



250-8455

Ford SYNC 3

Multi Camera Interface

Installation and User Manual

Table Of Contents

Installation	1
Switching to the Interface	3
Interface Homepage	4
Interface Settings	5
Camera Control	7
HDMI Input	9
USB Input	12

Installation Diagram

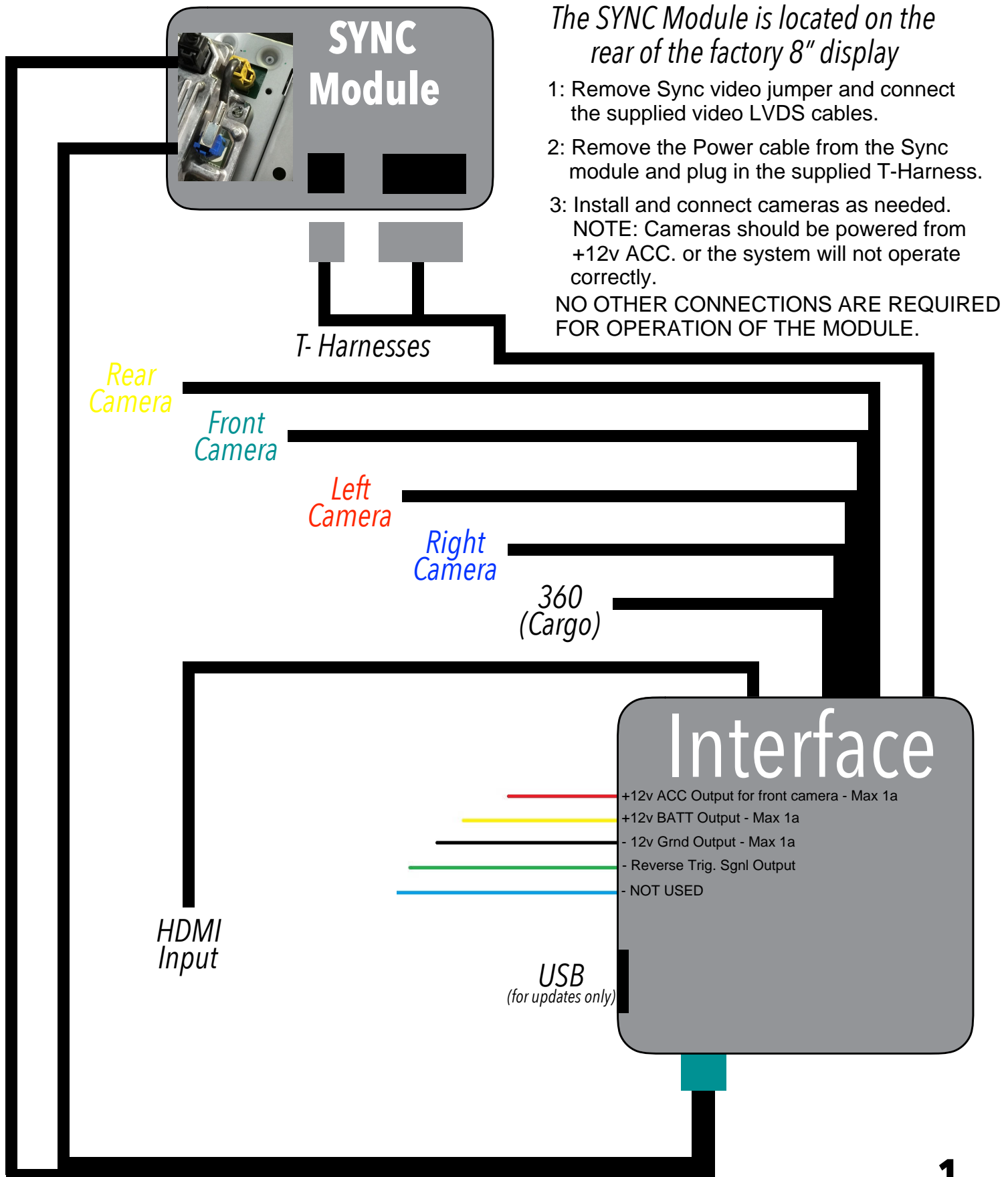

Installation Parts

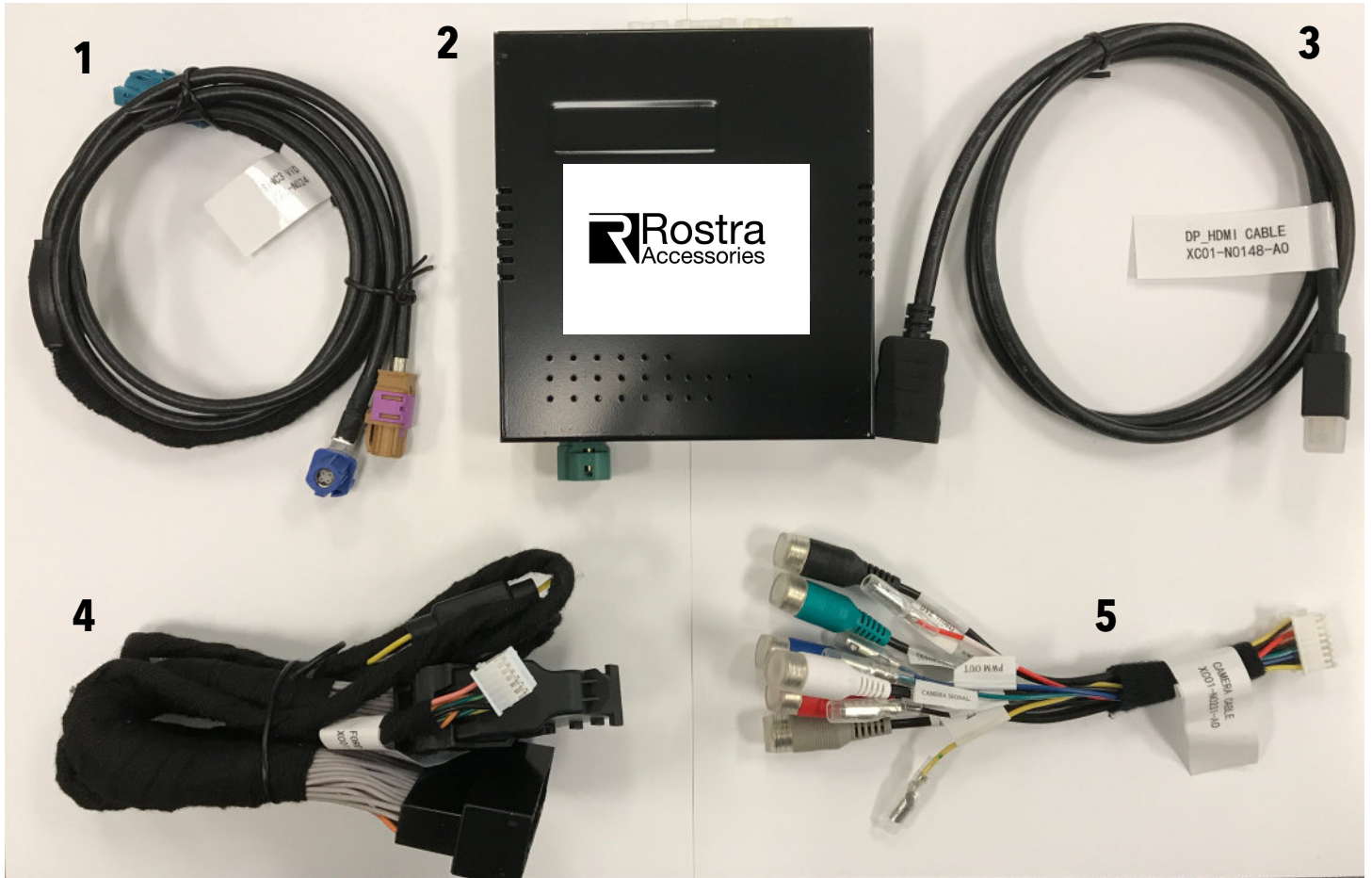

Parts List

- | | |
|---|-------------------------|
| 1 | LVDS Input/Output Cable |
| 2 | Interface Module |
| 3 | HDMI Input Cable |
| 4 | Power T-Harness |
| 5 | Camera Input Harness |

Switching to the Interface

Switching between the OEM system and your newly installed interface is easily done by pressing and holding the "Speak" button on the steering wheel for 3 seconds.

***The placement of the speak button may be different on your vehicle, this will not affect the systems functions.*

****The appearance of your steering wheel may be different than shown. This will not affect the functions of the interface..*

Pressing and holding the speak button for 3 seconds will access the interfaces's main menu. Pressing and holding the same button for another 3 seconds will return you to the factory systems.



NOTE: If needed the Voice button can be reprogrammed to the SOURCE button on the radio face. To program this follow these steps.

1: With the vehicle completely OFF press and hold the SOURCE button.

2: Turn the ignition on and hold the button for 30 seconds.

3: Release the button. Turn the vehicle off, make sure the radio shuts down completely.

4: Turn the vehicle back on, allow Sync to boot up as normal, then test the button by pressing for 3 seconds.

To reprogram the voice button follow the same steps above while holding the voice button.

Interface Homepage

Your interface menu homepage will look similar to the image below. Once you have accessed the interfaces Home Page, you can now use the touch screen to navigate through the interfaces sources and options.

To access the interfaces features, simply press the onscreen icons

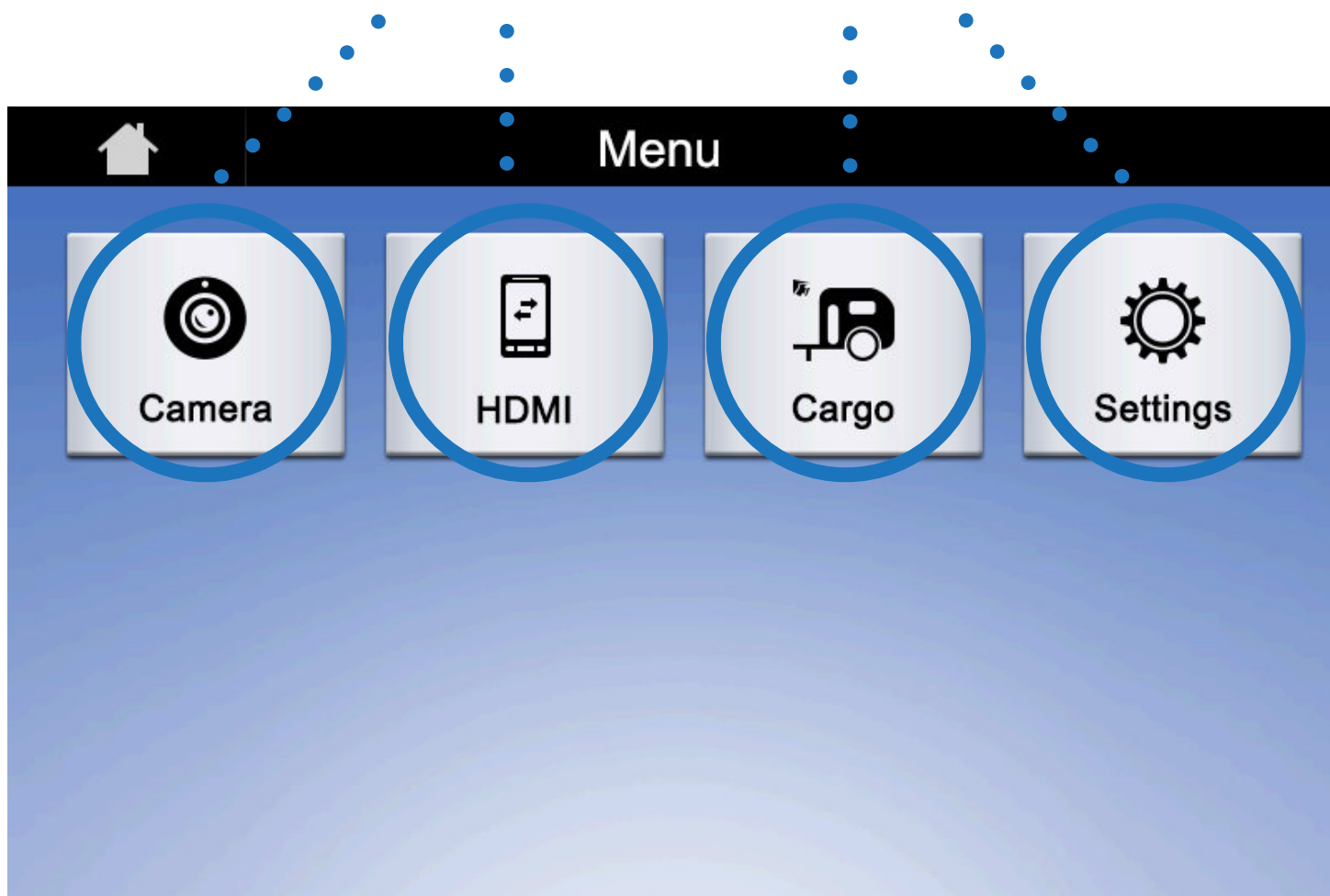

Interface Settings



The interfaces Settings allows you to do the following:

System Reset: Returns all systems setting back to factory default. It is also used when updating the firmware.

Rear Camera Options: Allows you to select which reverse camera input the interface will show while in reverse. Choose between OEM and aftermarket cameras.

Front Cam. Trigger by Speed: When checked, the front camera will automatically display when the vehicles speeds goes below 10 MPH.

Make changes by pressing the buttons now on your screen

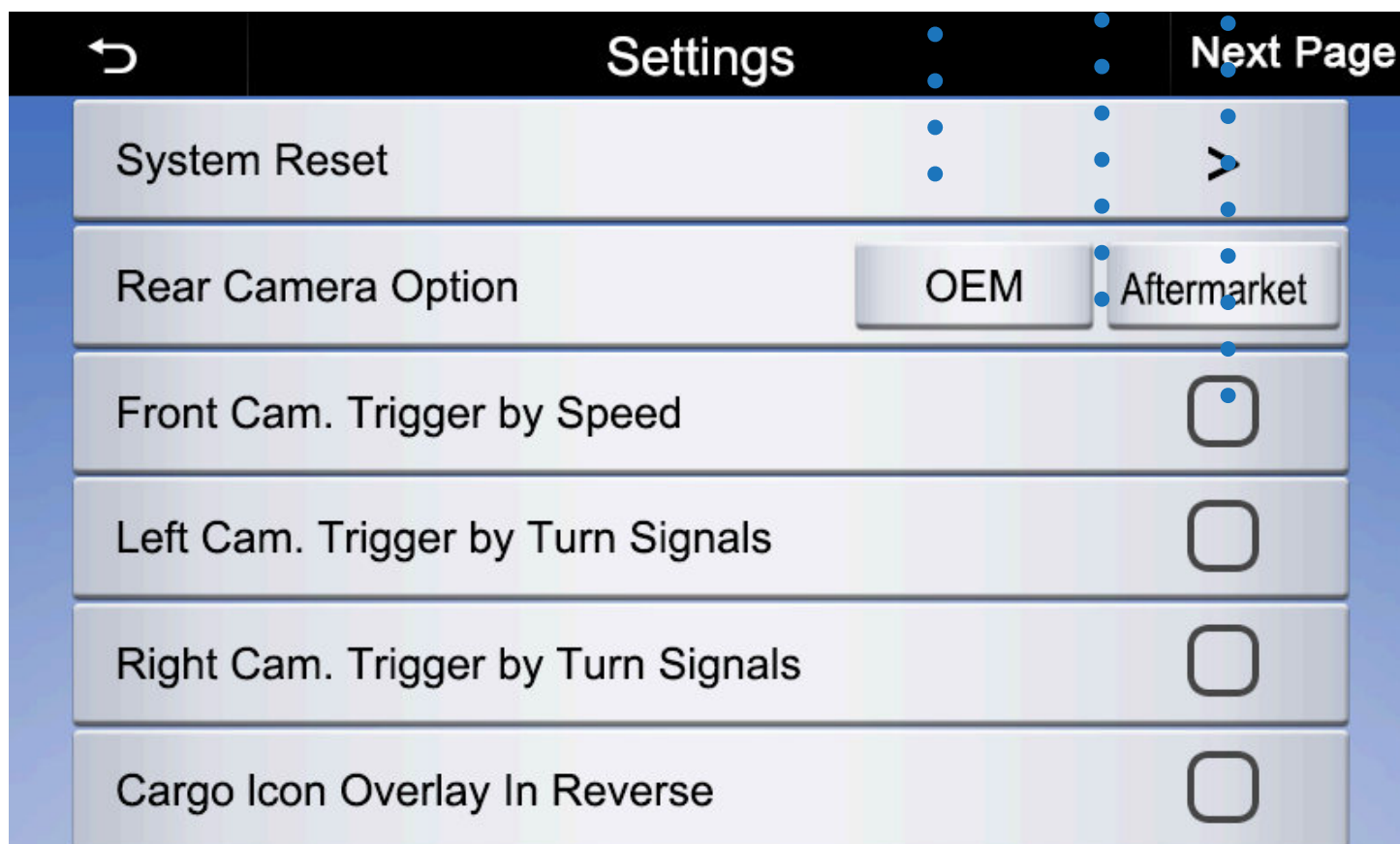

Interface Settings



Settings Continued:

Left Cam. Trigger by Turn Signals: When checked, the camera plugged into LEFT will display on the screen when the left turn signal is activated.

Right Cam. Trigger by Turn Signals: When checked, the camera plugged into RIGHT will display on the screen when the right turn signal is activated.

Cargo Icon Overlay In Reverse: When checked, the interface will add an icon to the touch screen while in reverse mode when using a Aftermarket rear camera only. Pressing this icon will switch you from your aftermarket camera you have plugged into REAR to the camera plugged into the 360 input. Ideal for cameras on the rear of a trailer or inside to monitor cargo.

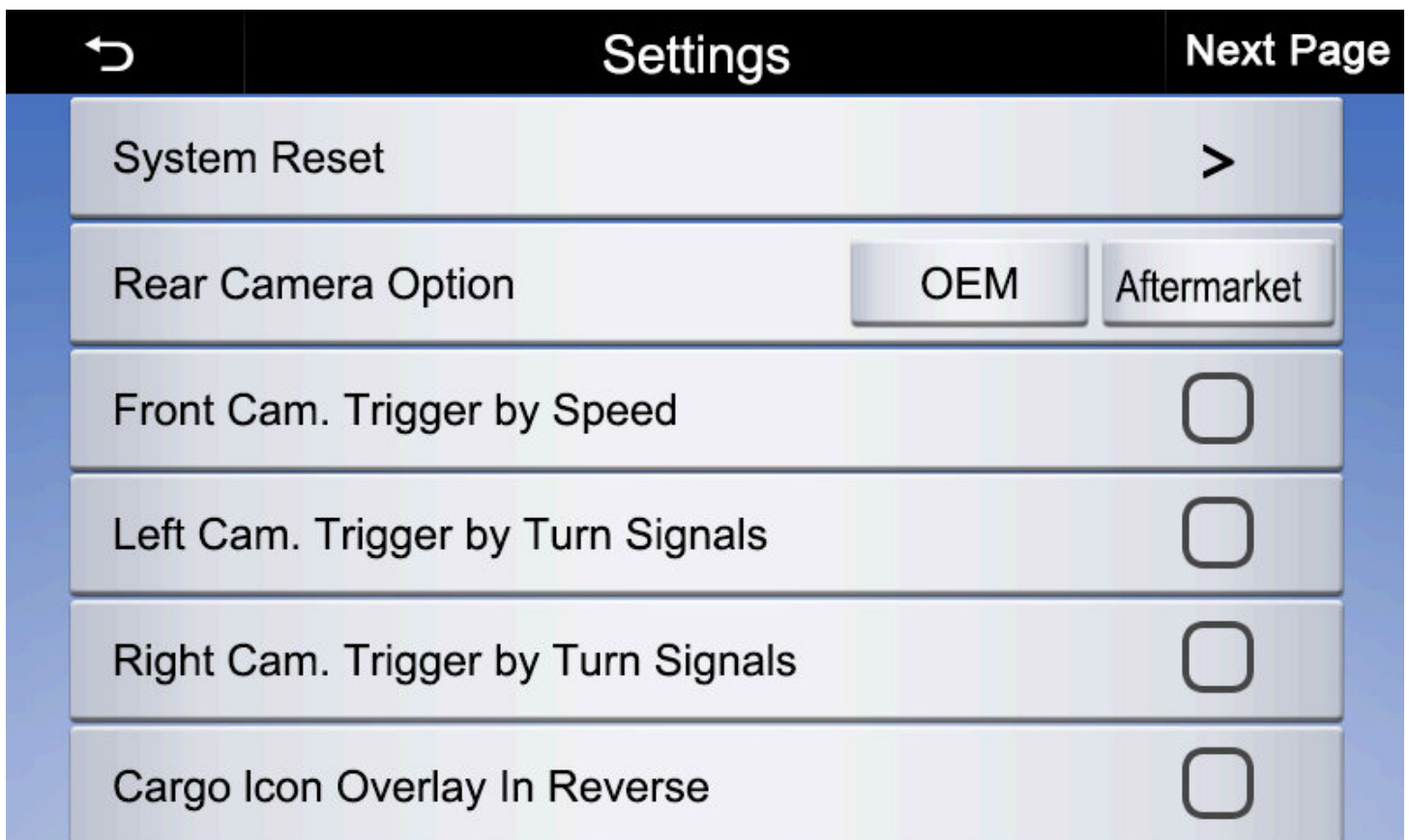

Cameras Must be installed in order for some features to work

Camera Control

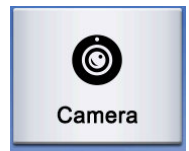

Pressing the Camera icon will allow you to access the installed cameras on demand.

When viewing the cameras, touch the screen again and the camera selection icons will appear. Touch any of the icons on the screen to view a connected camera. If you do not touch an icon within 10 seconds, the icons will disappear. Touching the screen again will bring the controls back.

The selected camera will continue to display until you press the return icon on the upper right hand side of the screen.

If there is no camera installed on selected input, the screen will remain black.

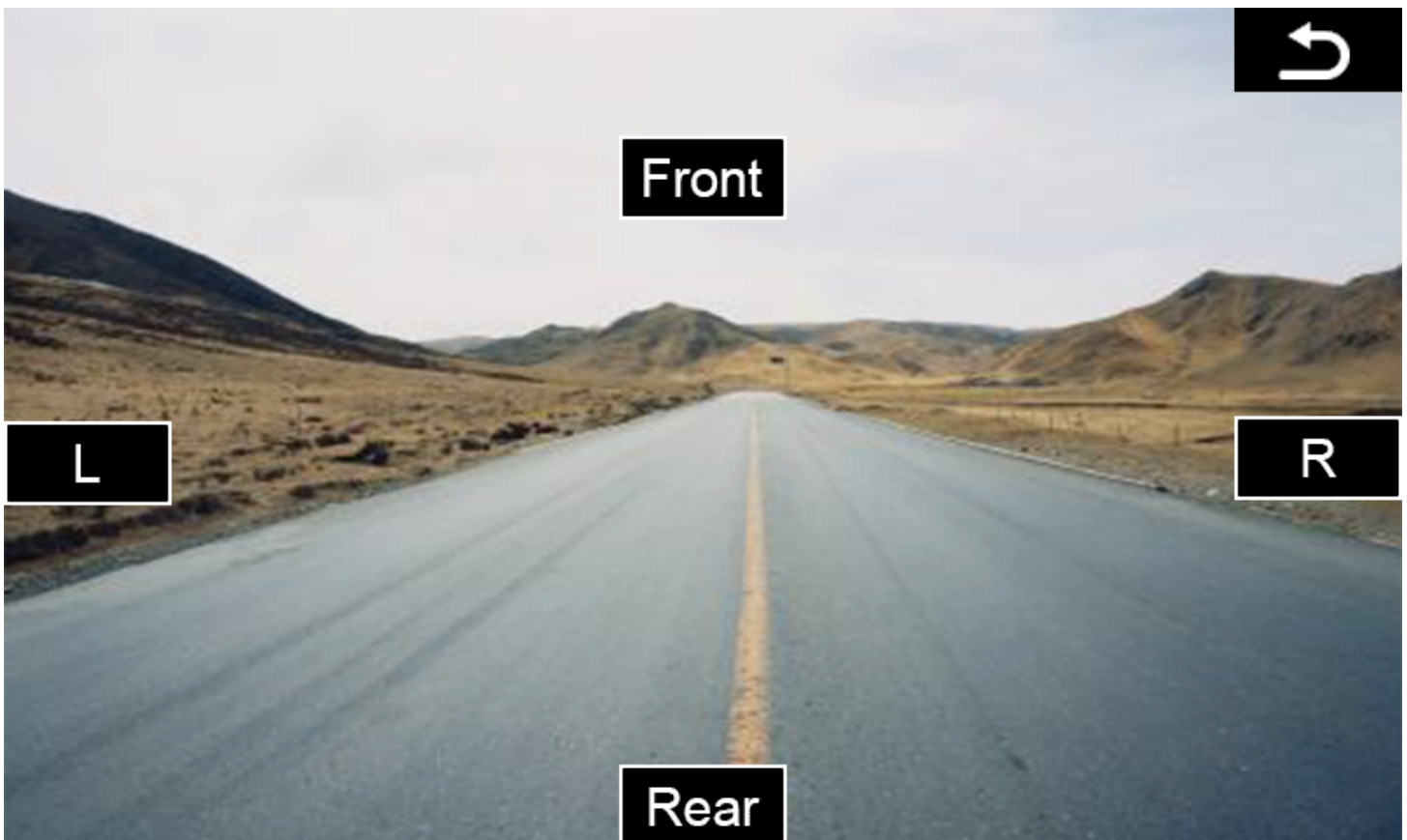

Cargo Camera Control

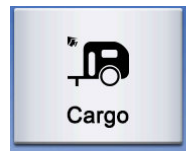

With the install of your new SYNC 3 Multi camera interface, you now have an option to add a 5th Wheel Docking, Trailer or Cargo Camera into your system with an OEM reverse camera.

By using the 360 Input on the interface.

Now you can access this camera by pressing the Cargo icon in the interface main menu page. Or if you have turned on the "Cargo Icon Overlay" and place the vehicle in reverse, a Cargo Camera icon will appear in the upper right corner when using an Aftermarket rear camera ONLY. Pressing the Cargo Camera Icon will switch from the aftermarket camera connected to the REAR input, to the camera that is plugged into the 360 Input.

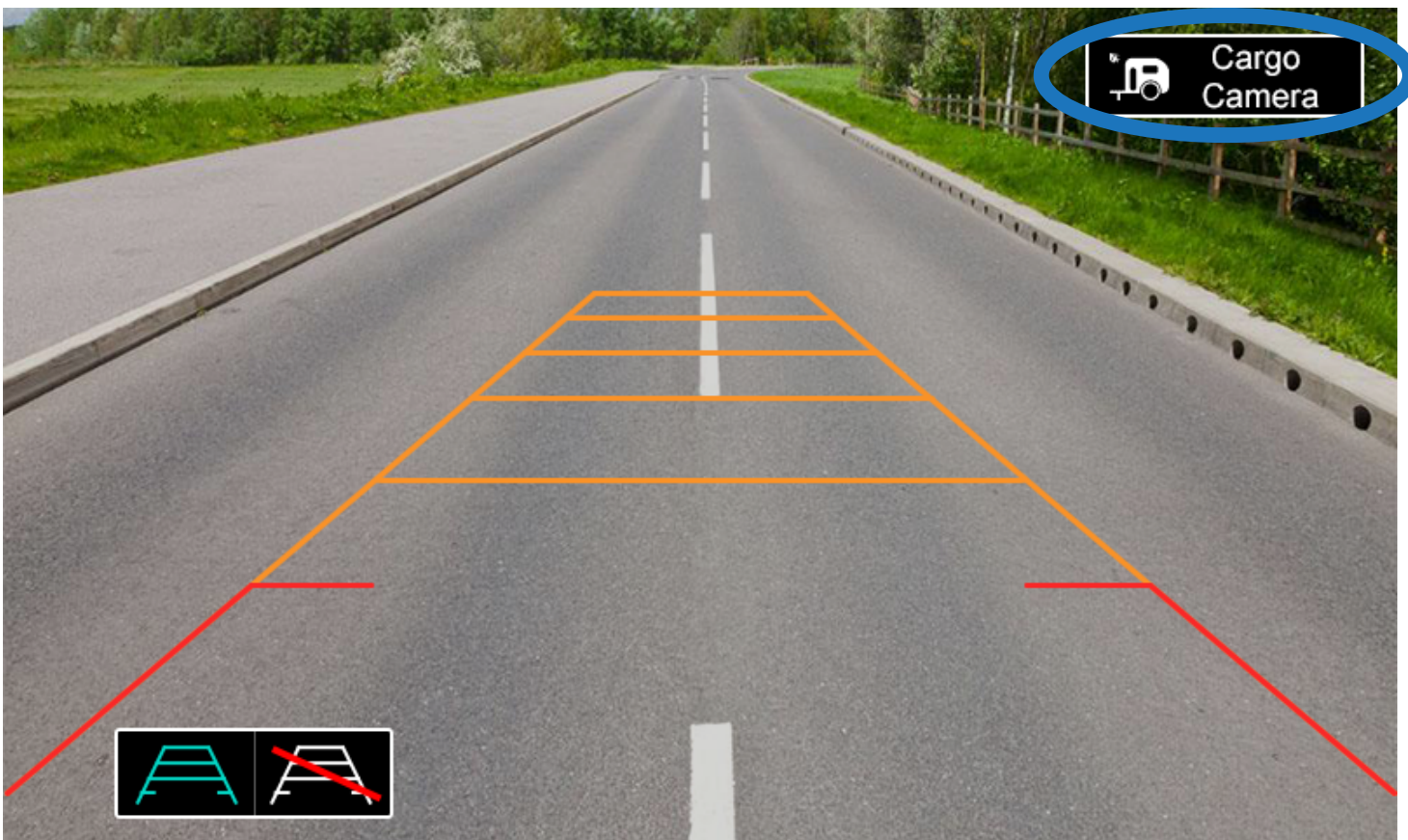

*** You must turn on this option in the interface settings in order for this feature to work***

HDMI Input



Your interface now offers you an HDMI input that you can use to view your compatible smart phone's screen on the factory display. This input DOES NOT offer control of the connected device, only the mirroring of the video and audio are accessible.

****FMVSS and local laws do not allow the viewing of video by a driver or in a position the driver may view** while the vehicle is in motion. Therefore we recommend that this function is used only for view applications such as navigation from your phone while driving. Driver safety is always a first priority.**

NOTE: You're phone will require a special cable or adaptor to view HDMI. Contact your Phone dealer for more info. (1080P, 720P, and 480P are supported)



HDMI Input



Steps To Mirroring Your Phone:

Step 1

Pair your device to the Ford SYNC 3 Bluetooth.

(For instructions on how to pair your phone to your vehicle refer to the factory owners manual)

Step 2

Select Bluetooth as your source.

Step 3

Access the interfaces main menu by pressing the HOME button twice quickly.

Step 4

Press the HDMI icon on the screen

Step 5

Plug your device into the HDMI input.

Once the device is plugged in, the interface will automatically switch the video and will display all images showing on your device.

The radio source must be on Bluetooth for the phones audio to play.

To exit out of HDMI Mirroring tap the screen and the return arrow icon in the upper right corner will appear. Press the icon and return to the Interfaces main menu.

If you don't press the return icon with in 10 seconds the icon will disappear.



HDMI Input



Notes On HDMI Mirroring

If you are using the HDMI mirroring to display your phones navigation onto the factory display you will have to have the radio source selected as Bluetooth in order to receive audible turn my turn prompts.

Using any application such as Netflix, youtube, Google Maps, Facebook, Etc., require data. For more information regarding data usage contact your Cell Phone Provider.

Again, the HDMI input does not offer screen control. You will need to do all the controlling and navigating of the phone's apps and sources by using the phone itself.

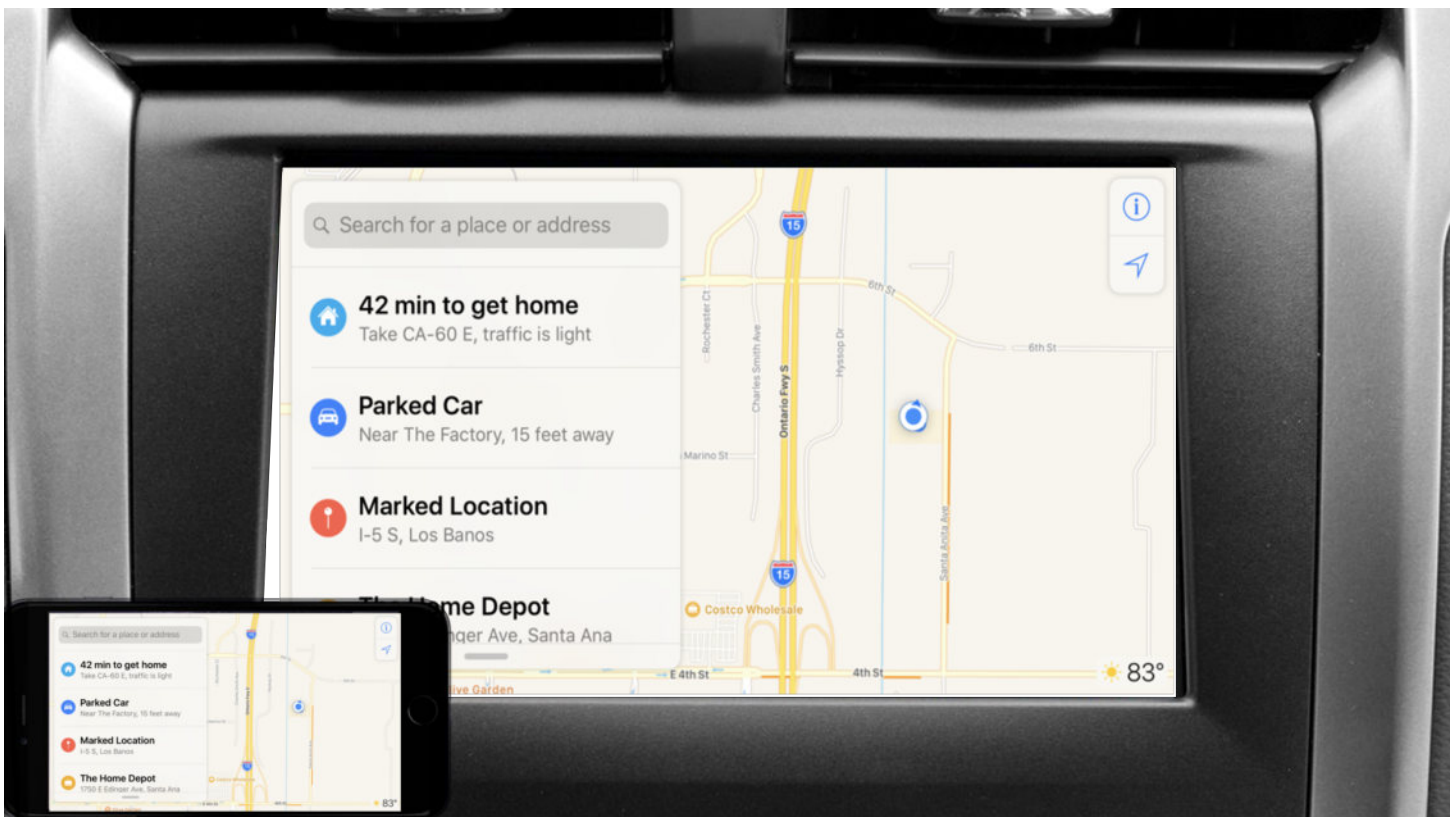

USB

The USB added to your interface will ONLY provide a place to charge your device.
The USB is NOT used for an AUX input or for a media player.

The USB will not play media, video, or pictures from any type of USB stick or other
USB connected device.

The USB Jack is designed and used to do any firmware updates on the interface

