

250-8454 Installation Instructions

Select GM Vehicles with 7" Screens

This manual shows a typical installation. Your vehicle may vary. Use caution and if unsure seek professional assistance.

Vehicle Preparation

Before beginning your installation, familiarize yourself with the installation instructions and the RearSight® camera system components.

To ensure your safety, (A) apply the emergency brake and (B) read this entire manual before beginning.

CAUTION: Disconnect the negative battery cable at least 3 minutes before beginning installation. This is advised to avoid unintended air bag deployment or possible damage to vehicle computer components. Damage to vehicle components is not covered by Rostra.

Components



Interface Module



HDMI Cable



Vehicle Connect
Cable



Camera Cable



Video Cable



Mounting Tape

1) Carefully remove the radio bezel by using a nylon pry tool. Use caution to not scratch the panel or dash.



2) Remove the four screws holding the control panel and A/C controls. Gently pull the panel away from the dashboard.



3) Lean the control panel forward and disconnect the wiring harnesses from the backside. Set the panel safely aside.



4) Locate the HMI module behind the control panel and disconnect the two leftmost connectors.

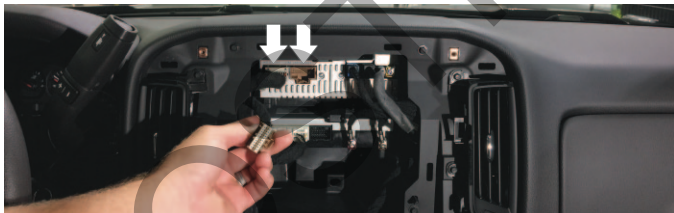

5) Insert the harnesses from the HMI module into the included t-harnesses. Insert the t-harness ends into the HMI module.

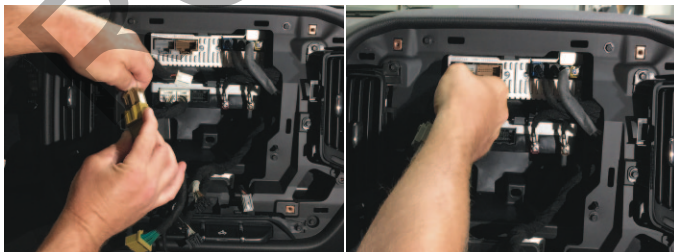

6) Disconnect the **Black** LVDS cable from HMI module, insert it into the LVDS t-harness and, insert the t-harness into the HMI.

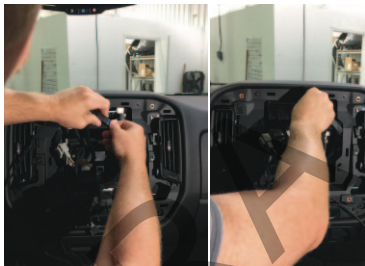
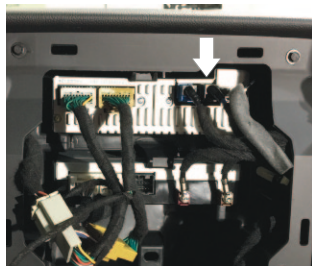

7) Insert the LVDS t-harness and power/video harnesses into the RearSight® Interface Control Module.



8) Temporarily reconnect the vehicle's battery as well as the LCD/control panel. Turn the ignition key to the *On* position.

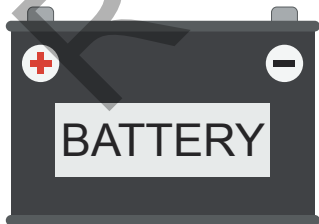

9) After the factory infotainment system has booted, quickly press the *Home* button 2 times to enter the interface menu.



10) If the screen enters the RearSight® interface menu, all connections to the vehicle are complete. Next you will connect your cameras to the RearSight® interface module. Install your cameras per the instructions provided with them. Run power for each camera from an ACC +12V source. Route your camera RCA cables to the Interface module location.

11) Once all connections are made, the module can be mounted or located anywhere behind or near the control panel. It is up to the installer to determine the best mounting location and route their wiring accordingly.

Camera Connections

Note: All Cameras MUST be wired to ACC +12V in order to use the monitoring functions. The red wire on the Rear Camera input lead will provide power when the aftermarket rear camera is activated and selected. **DO NOT** connect the camera power leads to the turn signals or reverse lamps. The RearSight® interface uses CAN technology to select the correct camera to display.

Camera Connections Continued...



We recommend using Rostra RearSight® cameras with the ability to reverse your image or select images without parking lines. RearSight® Blindspot cameras are designed specifically for this application.

Camera Settings

If the vehicle has a factory rearview camera, the rear camera input may be used for a cargo, fifth-wheel, or any other application. Selection of the factory rear camera is made under the *Settings* icon.

Settings 

System Reset OK Cancel

Rear camera options OEM Aftermarket

Front Cam. Triggered by Speed.

Left Cam. Trigger by Turn Signals.

Right Cam. Trigger by Turn Signals.

Cargo Icon Overlay In Reverse

- System Reset - Resets system to factory options.
- Rear Camera Options - Select from OEM or aftermarket camera.
- Front Cam. Triggered by Speed - Speed powers camera On/Off.
- Right/Left Cam. Trigger by Turn Signals - Cameras On/Off with signal.
- Cargo Icon Overlay In Reverse - Overlays cargo icon on-screen.

HDMI Cable

The included HDMI input cable can be used to mirror the screen of your compatible mobile device to the vehicle's built-in LCD screen when connected.

Installer Note: Please contact the manufacturer of your mobile device to determine if it is cable of HDMI output.



Wiring Diagram

System Connections:

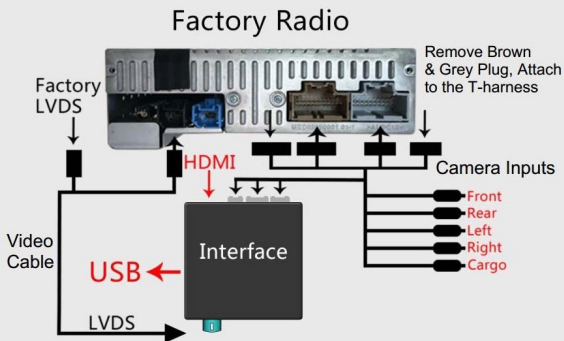

Note: USB for Updates Only - No cable included.

ROSTRA



Rostra

12-Volt Accessories

The leader in comfort, safety, and convenience.

© 2017 Rostra, Inc. 2519 Dana Dr. Laurinburg, NC 28352